

Nr. 57

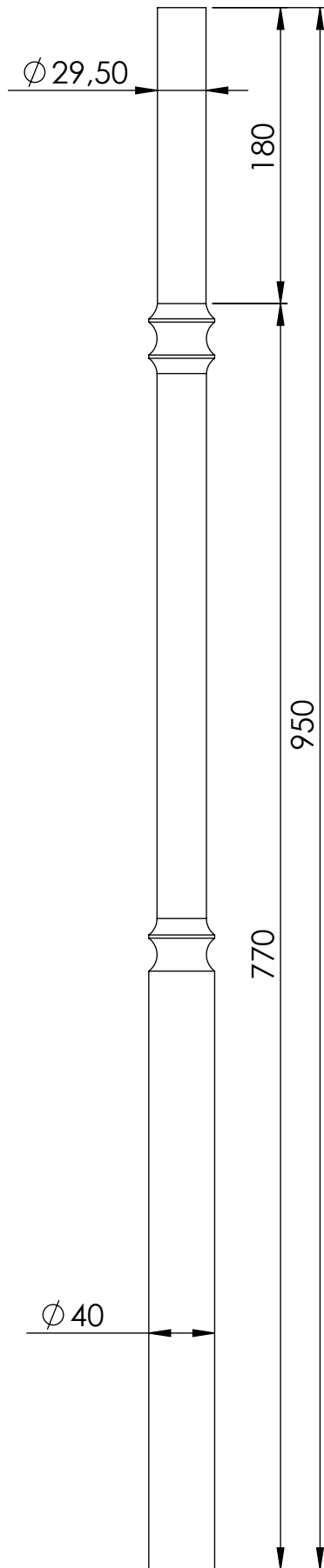

Nr. 57